

OEM Replacement Thermocouples

Direct Replacement Thermocouples

- * All the following thermocouples are manufactured with the highest quality materials and workmanship.
- * The thermocouple wire is stranded (for flexibility) ANSI Type J thermocouple grade, with ANSI color-coded fiberglass insulation (White=Positive, Red=Negative).
- * All hot junctions are grounded. Spade lugs where required are insulated and accept a No. 6 stud.

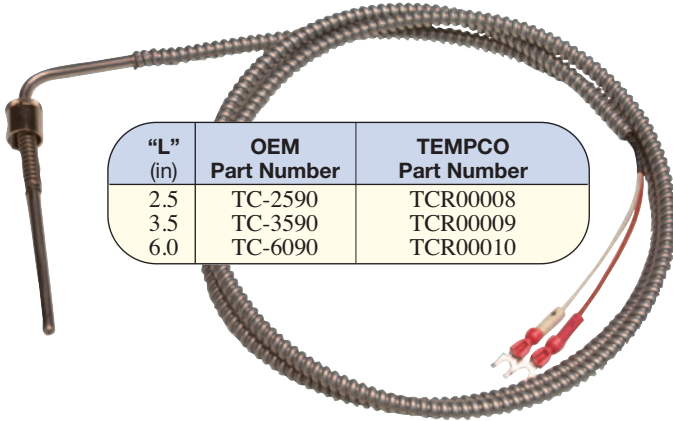

"L" (in)	OEM Part Number	TEMPCO Part Number
2.5	TC-2590	TCR00008
3.5	TC-3590	TCR00009
6.0	TC-6090	TCR00010

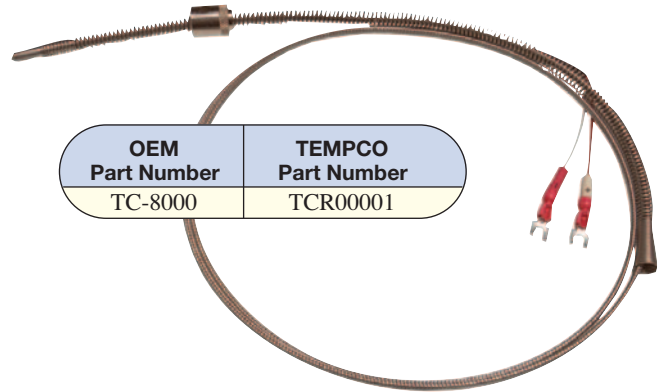
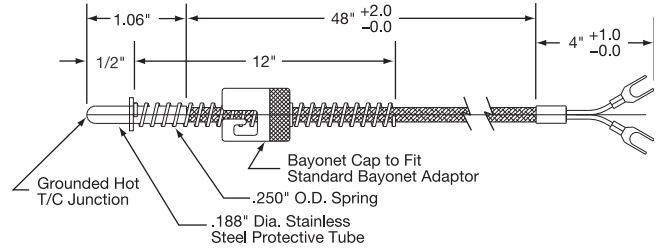

OEM Part Number	TEMPCO Part Number
TC-8000	TCR00001

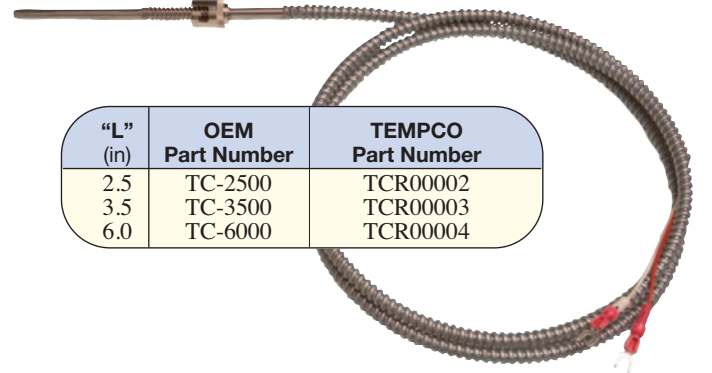
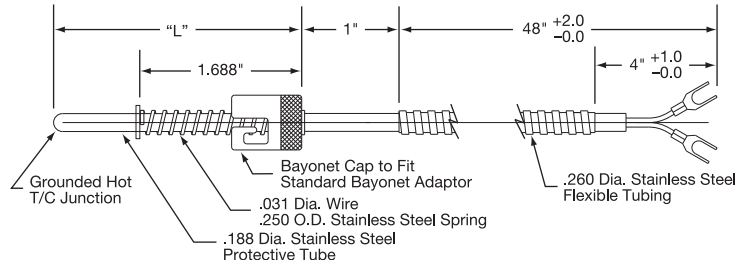
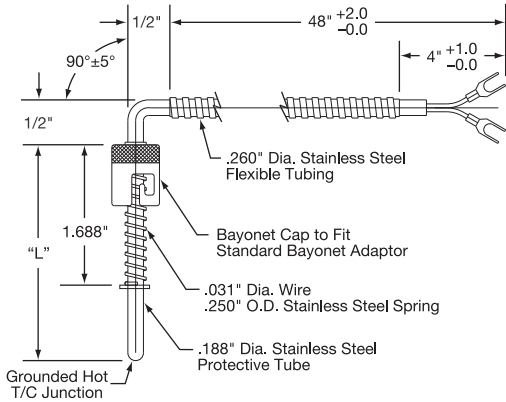

"L" (in)	OEM Part Number	TEMPCO Part Number
2.5	TC-2500	TCR00002
3.5	TC-3500	TCR00003
6.0	TC-6000	TCR00004

All Items Available from Stock

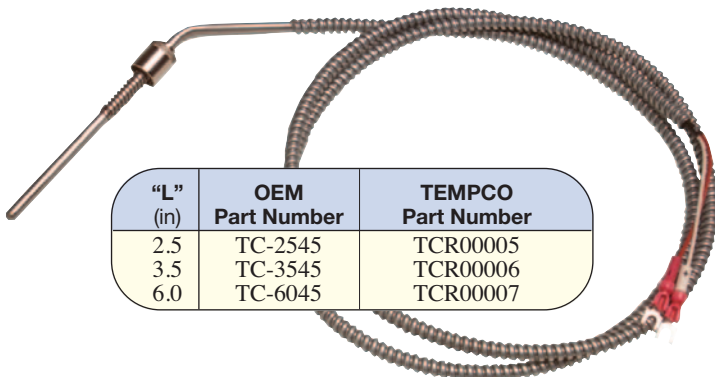

"L" (in)	OEM Part Number	TEMPCO Part Number
2.5	TC-2545	TCR00005
3.5	TC-3545	TCR00006
6.0	TC-6045	TCR00007

